

---

# MOON **KITCHEN SOLID M-8**

---

EN

Product card

---



Live light at  
**vandermoon.com**





Since 1993, Vitberg has been producing medical devices  
for rehabilitation, treatment, cosmetology and sports.  
Its products are known and appreciated.

Medicine and technology are not our only passion,  
we also love exploring the world.

**We have translated the experience gained over the years into**  
the production of accessories for people like us.  
This is how the Van Der Moon brand was born.

Made in Poland, EU.  
[www.vandermoon.com](http://www.vandermoon.com)

**Moon Kitchen Solid** is an advanced camper kitchen designed for vans and campervans. The structure is made entirely of 1.5 mm thick aluminium, with each element precisely cut and joined with aircraft rivets for maximum strength and resistance to vibrations while driving.

Available in three configurations: **Shell** for users who prefer their own finishes, **Front** with ultra-thin HPL fronts with hidden screws for a professional look.

The access system uses a proven lever handle for secure closure while driving and immediate access to contents. The adjustable rear panel allows for optimal fit to the vehicle's ribbing, recovering up to 4 cm of space inside the car.

The reinforced construction with guides supports drawer loads of up to 20 kg each. Smart drawers with aluminium dividers offer 3 adjustable spaces in each section. A dedicated compartment accommodates all water, electrical and gas installations with an aluminium panel for sockets.

Numerous mounting points to the floor and side wall ensure secure integration with the vehicle. Quick-release connectors and airline rails allow the kitchen to be completely dismantled in a few minutes without losing functionality.

All production processes are carried out in a Polish factory with rigorous quality control at every stage.

## Universal product – for every car model



Moon Kitchen Solid Model 8, version Front

# Available **versions** and **configurations**

		MODEL
		<b>Model 8 (KM8)</b>
DIMENSIONS	width	1100 mm
	height	900 mm
	depth	510 mm
VERSION	<b>Shell</b> version without fronts, without worktop, with recess	●
	<b>Front</b> version with fronts, without worktop, with recess	●
OTHER	<b>Countertop</b> worktop for the selected model	●
	<b>Countertop with sink</b> worktop with sink, on the right or left side	●
	Spacious cargo drawer: 740 x 475 x 478 mm (width x depth x height)	●
COMPATIBILITY WITH REFRIGERATOR MODEL	<b>REFRIGERATORS:</b> DOMETIC: CFX2 28, CFX2 37, CDF 36, CDF2 36, CFF 45, Waeco CF 40, CFX5 55IM, CFX3 55 MOBICOOL: MCF32, MCF40 TRUMA: Cooler C30, Cooler C36 YOLCO: GCX37, BCX30, BCX40, ET18, KX30, NX30, NX40 INDEL B: TB18, TB31, TB41, ITB32, ITB42 YETICOOL: CX10, ET18 (17L) VEVOR 40 l EcoFlow Glacier Classic 35L ICECO JP40, JP40 Pro  Mobicool MCF40 Vigo Cool 40L Alpicool CF3, C40 ICECO JP40, JP30 Pro Engel MT2 ARB Classic Series II 35L ARB ZERO 36L Evakool Infinity RFE47-FF Bushman SC35 Evakool Infinity SnoMaster LS35 SetPower RV45D Engel MT27, MT35 ARB Classic Series II 35 L BougeRV CRD2-40 BODEGA CF45 ICECO JP40 Pro and many other older models.	
	<b>COOLBOX:</b> DOMETIC/WAECO TROPICOOL: TB08 (8L), TCX14 (14L), TB15 (15L), TCX21 (21L), TCX35 (35L) MOBICOOL: W40 (40L), MV26 (26L), MT30, MT48, Q40, T38, P-Series (various sizes), MCG Series (10.5L-38L) TOTALCOOL ECO-CHILL: 24L model, 33L model MESTIC: MTEC-28 (26L) COLEMAN XTREME: 28 quart, 40 quart MILENCO: Compact 12V	

Lever lock included in the set, fits **6 mm** thick worktops.



## Model 8

Shell

Size: 1100x900x510 mm  
Weight: 43.6 kg (+/-300g)

Available colours:



## Model 8

Front

Size: 1100x900x510 mm  
Weight: 51.3 kg (+/-300g)

Available colours:



## Model 8

Front    Countertop

Size: 1103x906x518 mm  
Weight: 55.8 kg (+/-300g)

Available colours:





## Model 8

Front    Countertop with sink

**Size:** 1103x906x518 mm

**Weight:** 56.9 kg (+/-300g)

Available colours:



**Countertop:** 4.5 kg (+/-100g)

**Countertop with sink:** 5.6 kg (+/-100g)

# Moon Kitchen Solid Model 8

The drawings show the **Front** version.

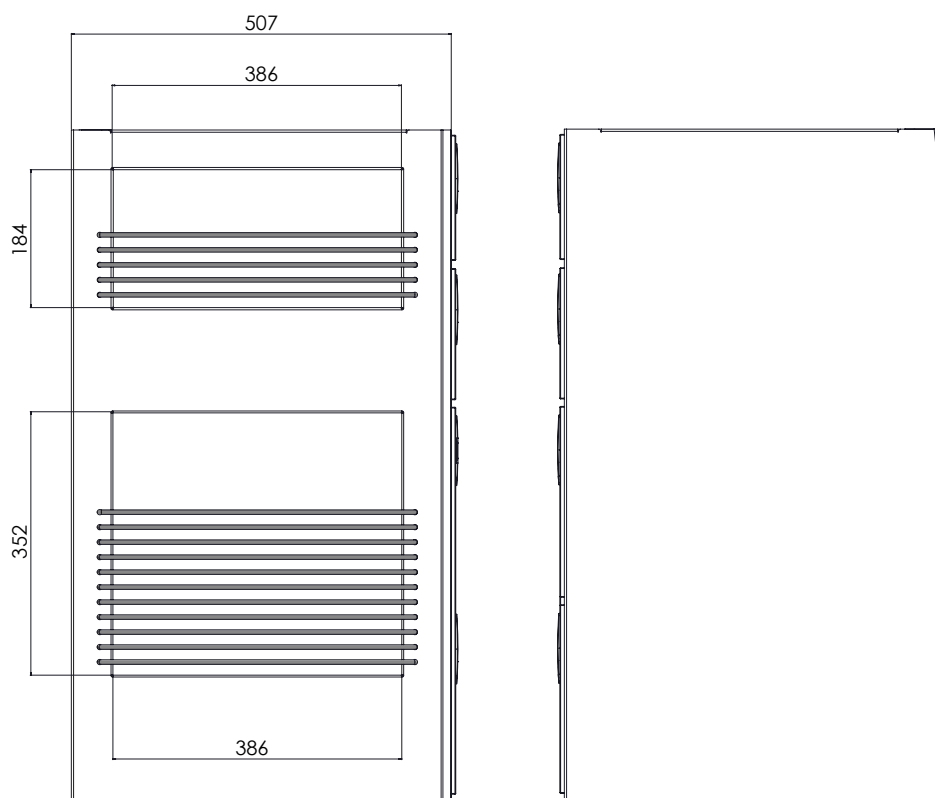
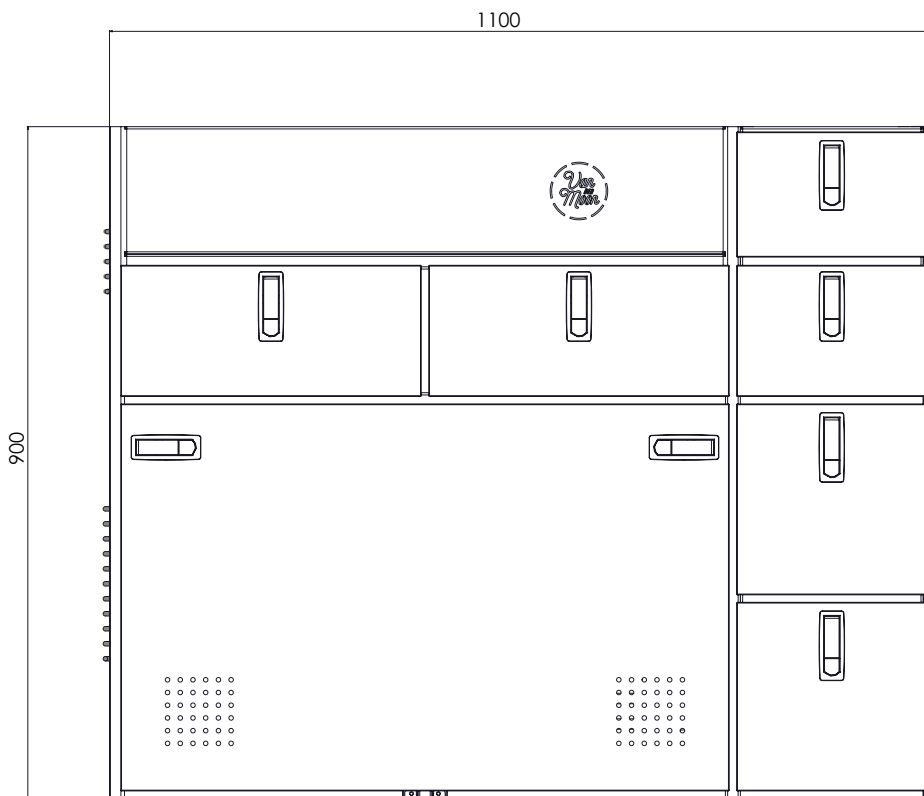

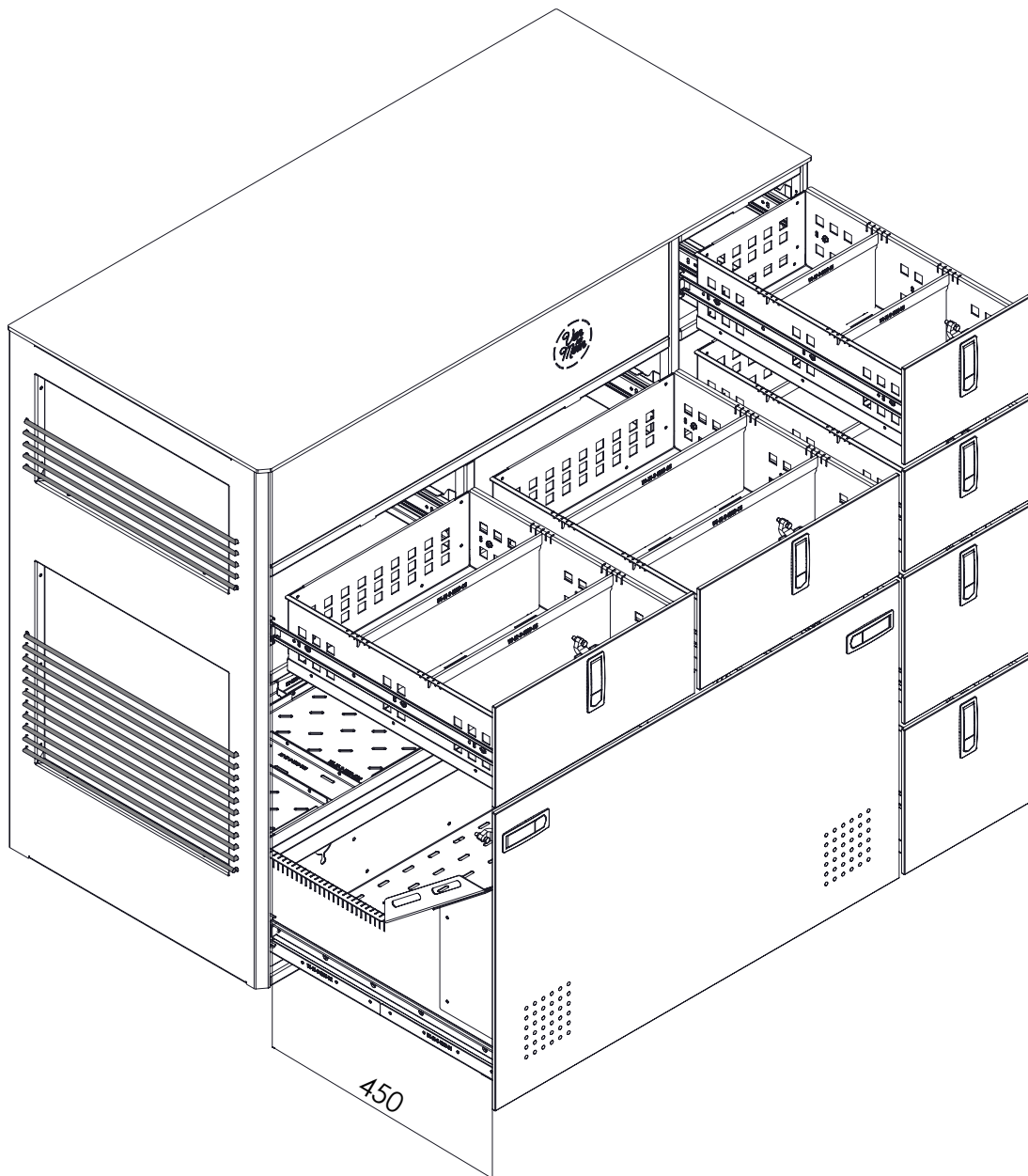
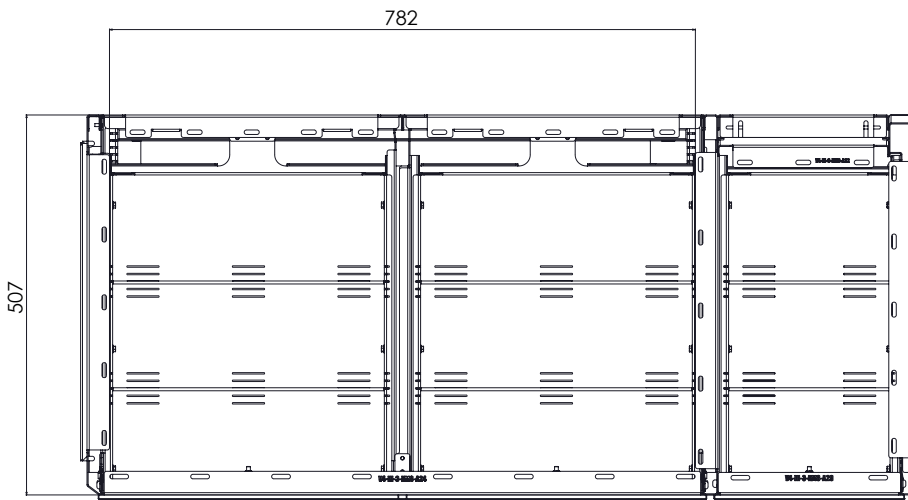

# Moon Kitchen Solid Model 8 – drawers

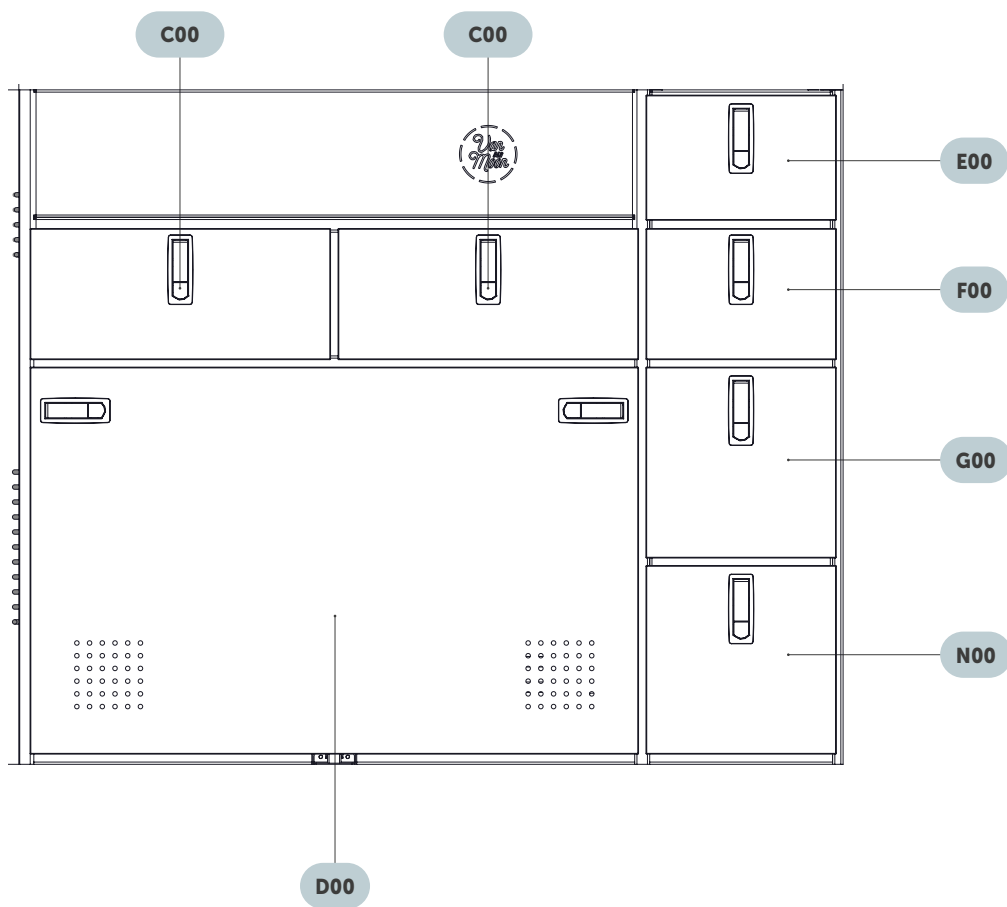

## Drawer – C00

Maximum drawer load

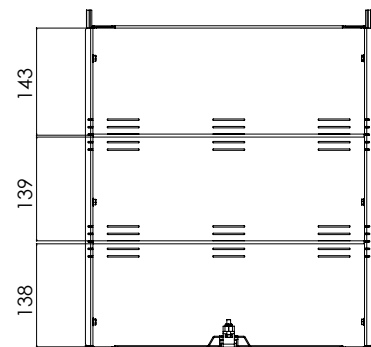
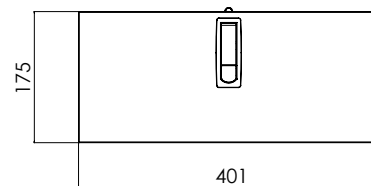
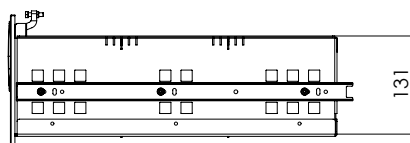
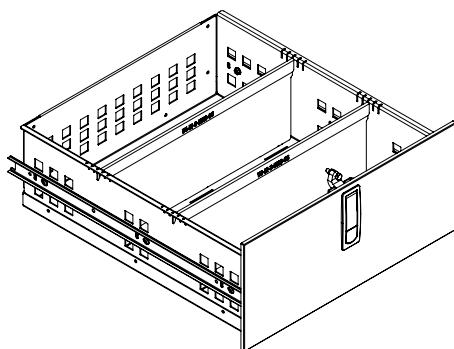

Drawer – N00

Maximum drawer load

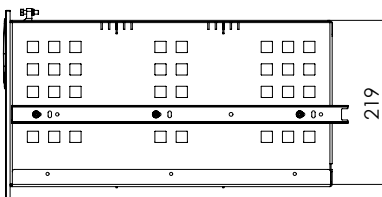
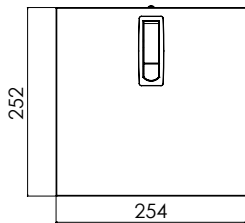
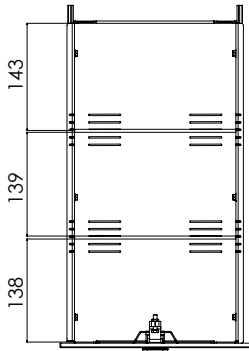
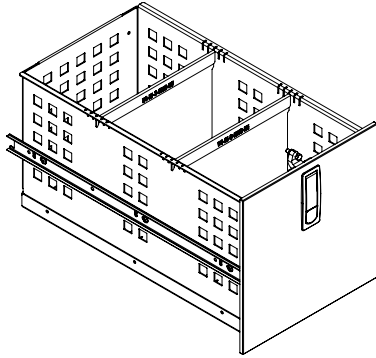

Drawer – G00

Maximum drawer load

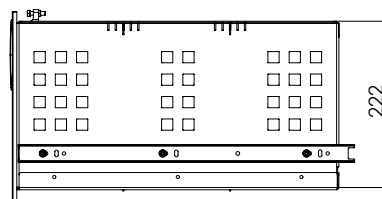
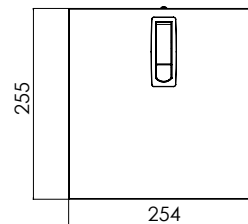
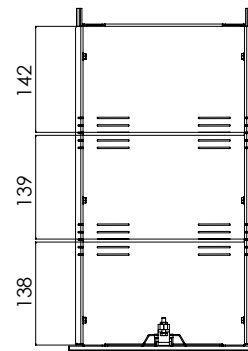
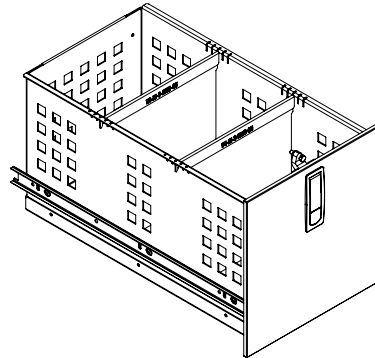

Drawer – F00

Maximum drawer load

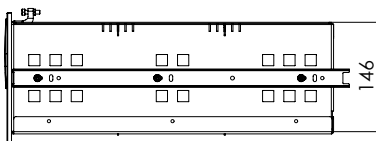
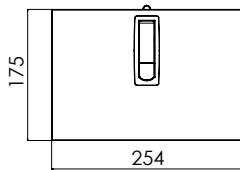
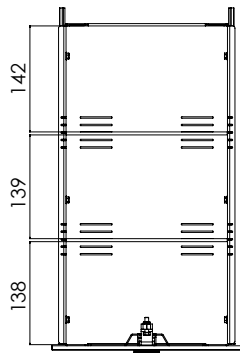
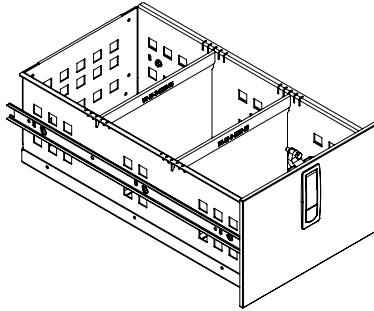

Drawer – E00

Maximum drawer load

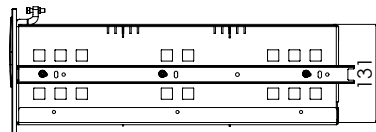
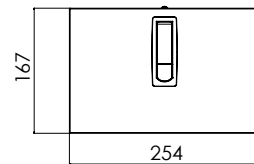
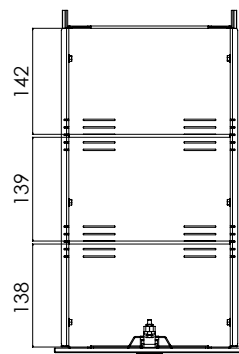
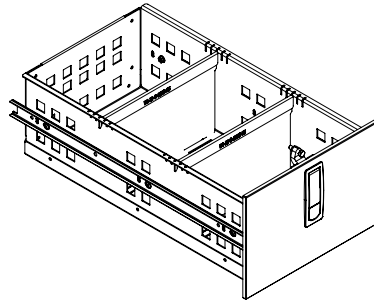

Drawer – D00

Maximum  
drawer load

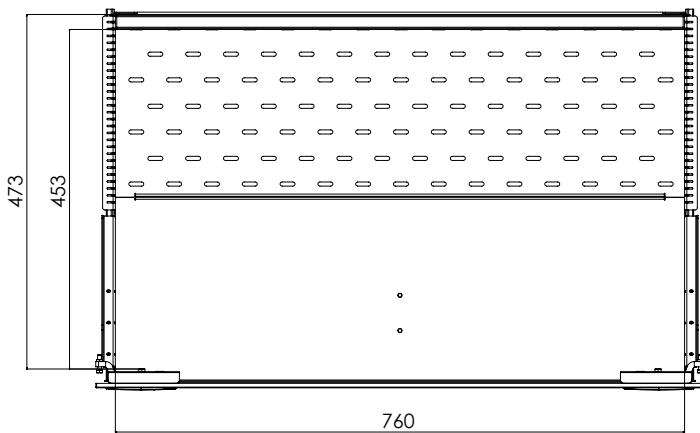
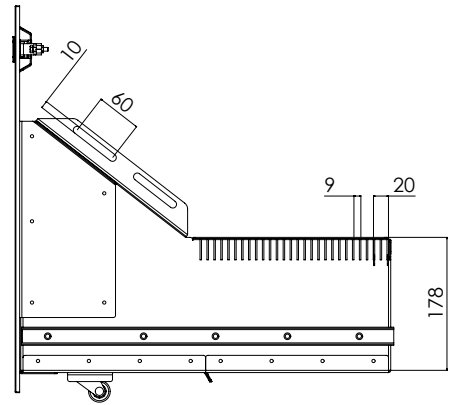
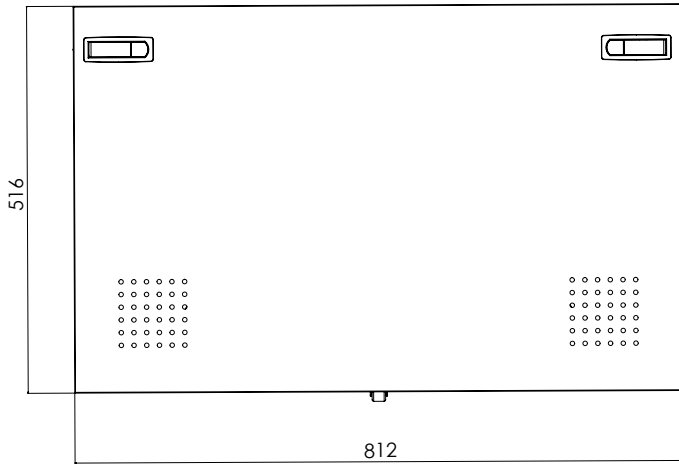
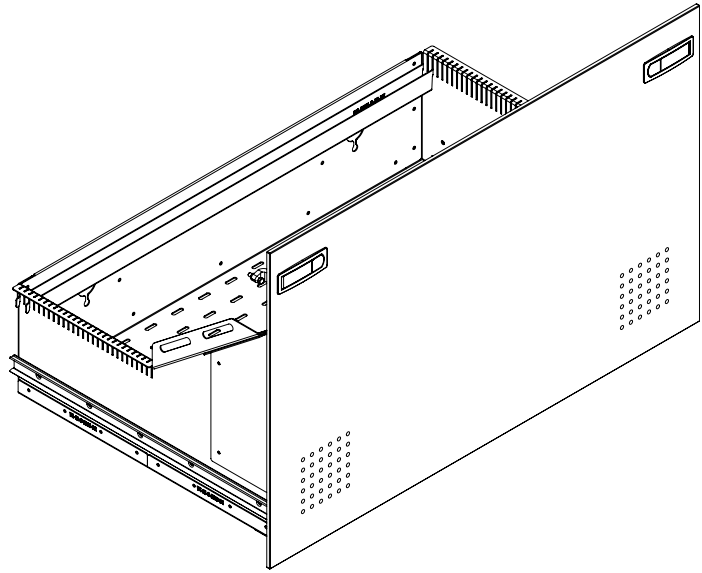

# Moon **Kitchen Solid Model 8** – countertop

countertop version without sink

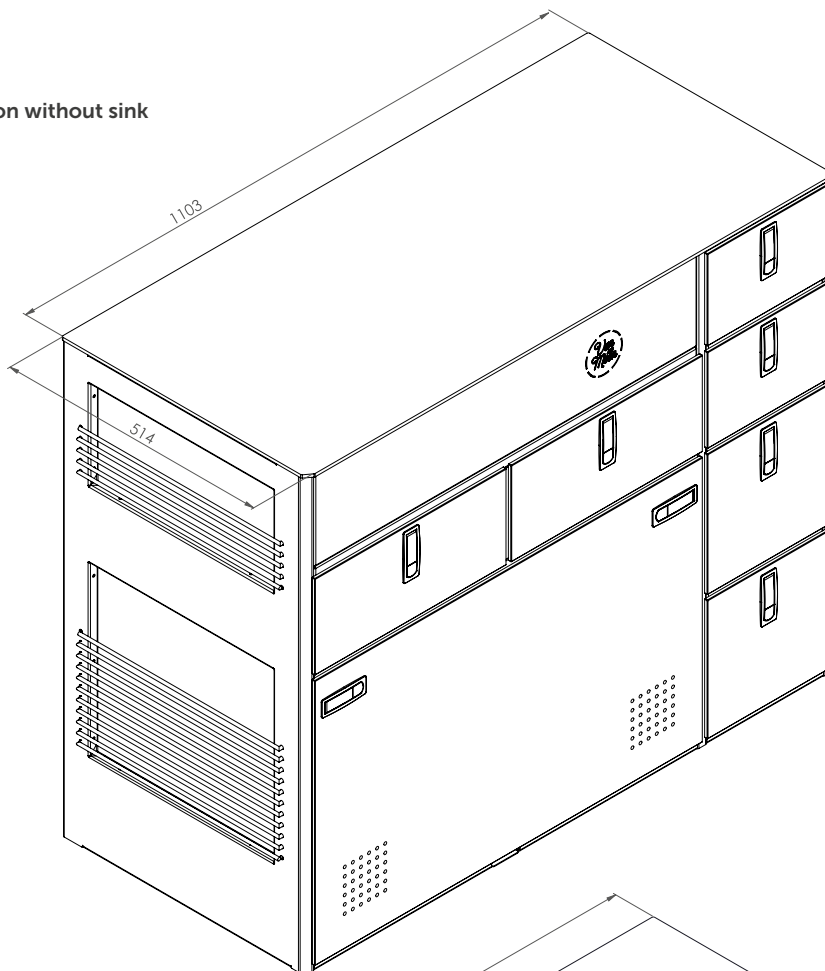

version with sink on the left side

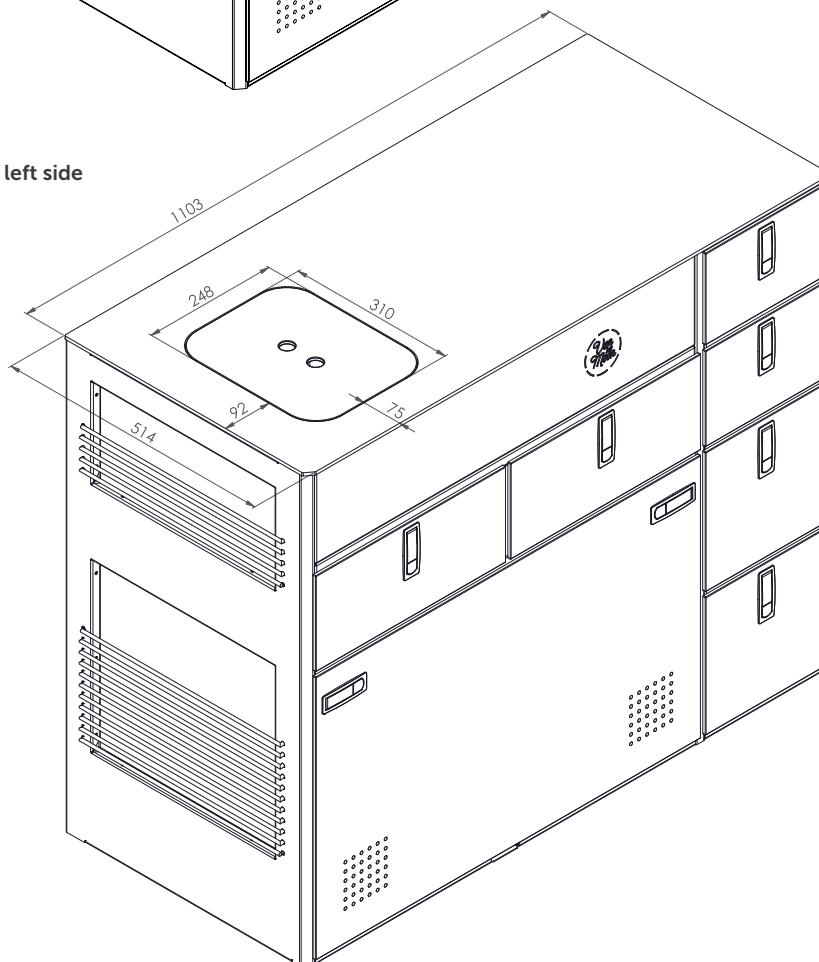

version with sink on the right side

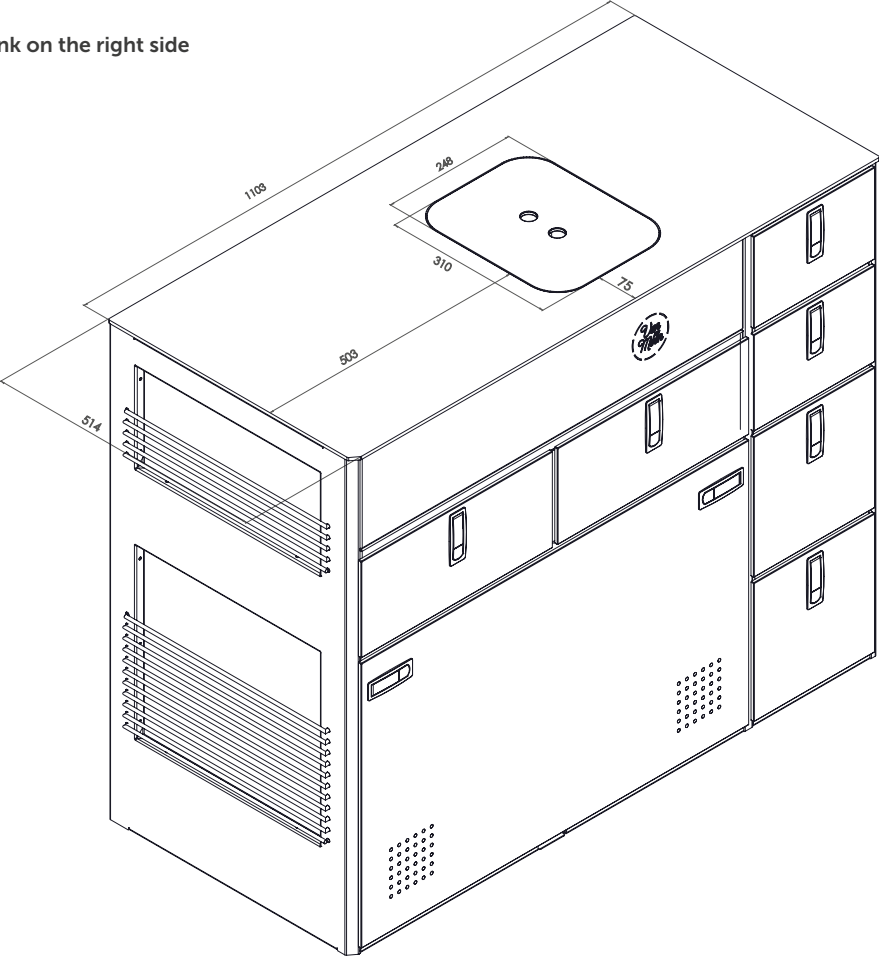

sink dimensions

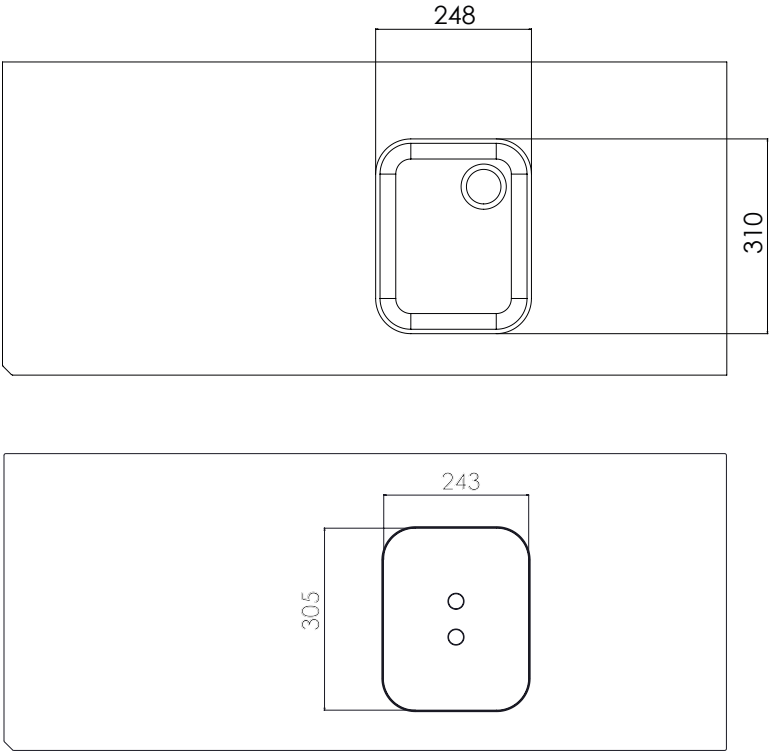



## Cleaning

Surfaces should be cleaned with a soft cloth and mild detergent.

Avoid abrasive materials and harsh chemicals.

Ventilation points should be kept clean.

Wipe dry after cleaning to prevent water stains.



## Composition

Aluminium construction, HPL fronts, professional fittings.



## Transport and storage

The products are packed in cardboard outer packaging.

During transport, they should be placed horizontally or vertically.

They should be transported in their original packaging..



## Disposal of the packaging

The packaging is made of recyclable cardboard, so it should not be thrown away, but disposed of in a landfill in waste paper bins or special containers for cardboard packaging.

Bubble wrap should be disposed of in a plastic and metal container after cleaning it of dirt and labels. If the film is heavily soiled or greasy, it should be disposed of in mixed waste. It is also worth considering reusing the film to protect items before disposing of it.



## Precautions

Read and understand all installation instructions before installing the Moon Kitchen Solid unit.

After installation, check the safety of the installation by applying moderate force to test the fastening.

Do not leave Moon Kitchen Solid in direct sunlight – this may cause the material to fade. However, this does not change the mechanical properties of the material.

Protect from moisture.

Keep away from open flames and heat sources.

Follow the guidelines for the maximum load capacity of the model.

Use appropriate tools for installation and opening the packaging to avoid damage.

Periodically check the mounting points and equipment for proper tightness.



[www.vandermoon.com](http://www.vandermoon.com)



**Contact**

tel. +48 18 442 33 69  
[shop@vandermoon.com](mailto:shop@vandermoon.com)